

Model 101 P2

Equipment Check

1. Turn sensitivity dial **fully clockwise**.

Notes: 1. Clockwise rotation of sensitivity dial turns meter on and increases sensitivity.
2. Always set switch to highest sensitivity position, then decrease if necessary.

2. Depress the Battery Test button to test the battery and circuitry (excluding the probe when not in use).
3. Submerge the probe in tap water. This completes the circuit and activates the buzzer and light.

The Tape Guide

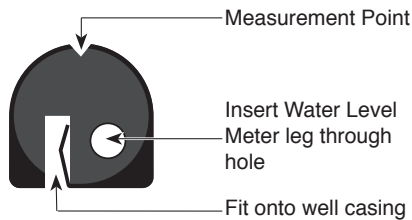

The Tape Guide has been designed to:

- Improve accuracy when reading water levels,
 - Easily obtain repeatable measurements,
 - Prevent tape being cut by well casing,
 - Allow the tape and probe to hang straight from the side of the well.
1. Fit the small end of the Tape Guide onto the edge of well casing 2" (50 mm) dia. or larger.
 2. Insert the leg of the Water Level Meter into the hole on the Tape Guide and rest the Water Level Meter on the side of the well casing. (See diagram above).
 3. To store the Tape Guide, simply clip it onto the support bracket located on the back of the Water Level Meter.

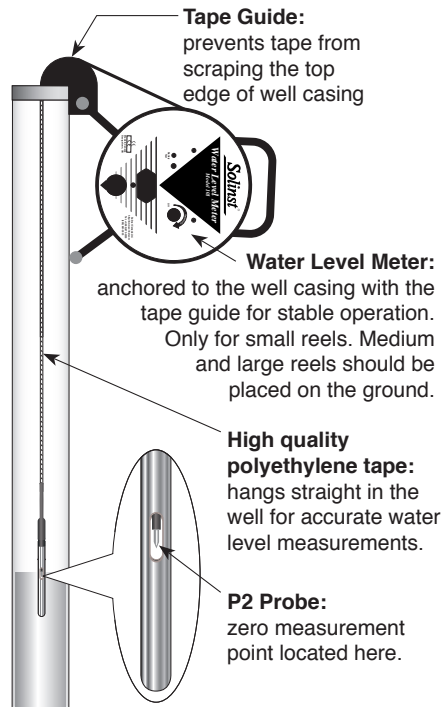

Water Level Measurements

1. The P2 Probe zero measurement point is the tip of the needle in the center of the probe.
2. For ease of operation the Tape Guide can be used to support the Water Level Meter. (See diagram above).
3. Feed the tape into and out of the well using the groove in the top of the Tape Guide. The light and buzzer activate when the needle tip enters water. To ensure accuracy, lower and raise the probe a few times and then record the depth measurement from the tape at the top of the well.
4. When using the Tape Guide, the measuring point is offset from the top of casing. To adjust your measurements to the top of the casing, simply subtract the amount indicated on the front of the Tape Guide (i.e. 6 cm or 2/10 ft).

Routine Care

1. After the depth to water has been recorded, the tape should be carefully rewound onto the reel, the probe wiped dry and placed into the probe holder.
2. The probe, tape and reel can be cleaned with phosphate free (non-abrasive) detergent and warm water.
3. Use of a Water Level Meter Carrying Bag adds to the service life of the meter.
4. Use of the Tape Guide adds to the life of the tape.

Probe Care and Cleaning

1. The P2 Probe should be wiped clean after each use.
2. Remove any dirt or water from around the central sensor pin.
3. If the central sensor pin is corroded or coated, use emery cloth to polish it.
4. Check the P2 Probe seal/strain relief and replace the black heat shrink if there is any cracking or other damage.
5. After cleaning, place probe back in its holder.

Battery Replacement

- Battery type - alkaline, 9 volt.
1. The battery is housed in a convenient battery drawer located in the faceplate of the Water Level Meter.
 2. To replace the battery, simply press the drawer in, lift then pull.
 3. The battery drawer should slide out of the faceplate enough to pull it out.
 4. Note the polarity (positive (+) terminal should be towards the small notch in the drawer) and place new battery in the drawer and slide it back into the faceplate.

Replacement Parts

The following parts can be provided should they become lost or damaged.

1. Probes and seal kits
2. Splice kits
3. Lights, switches, etc.
4. Reels
5. Replacement tape with probe (Complete)
6. Assembled probes on shorter lengths of tape

Troubleshooting

SYMPTOM	CAUSE	REMEDY
No sound when probe immersed in water.	Dead battery.	Replace with 9V Alkaline.
	Water Conductivity is very low.	Increase sensitivity switch setting (turn clockwise) or call Solinst for assistance.
	Disconnected wires on circuit board.	Check all connections inside hub of reel for loose/disconnected wires - solder or reconnect.
	Broken wire in tape.	Locate break in tape - splice and seal. (Contact Solinst)
Instrument continuously sounds after being immersed in water.	Disconnected wire inside probe.	Contact Solinst to obtain parts/repair instructions.
	Water in probe. Probe may be dirty which could interfere with the circuit connection.	Contact Solinst for probe seal kit. Disassemble, clean and reassemble probe using the new seal kit.

Equipment Check

1. Turn sensitivity dial **fully clockwise**.

Notes: 1. Clockwise rotation of sensitivity dial turns meter on and increases sensitivity.
2. Always set switch to highest sensitivity position, then decrease if necessary.

2. Depress the Battery Test button to test the battery and circuitry (excluding the probe when not in use).
3. Submerge the probe in tap water. This completes the circuit and activates the buzzer and light.

The Tape Guide

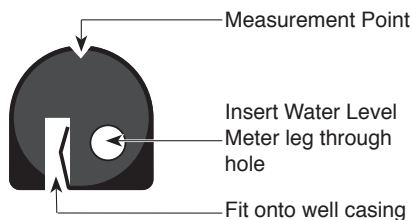

The Tape Guide has been designed to:

- Improve accuracy when reading water levels,
 - Easily obtain repeatable measurements,
 - Prevent tape being cut by well casing,
 - Allow the tape and probe to hang straight from the side of the well.
1. Fit the small end of the Tape Guide onto the edge of well casing 2" (50 mm) diameter or larger.
 2. Insert the leg of the Water Level Meter into the hole on the Tape Guide and rest the Water Level Meter on the side of the well casing. (See diagram above).
 3. To store the Tape Guide, simply clip it onto the support bracket located on the back of the Water Level Meter.

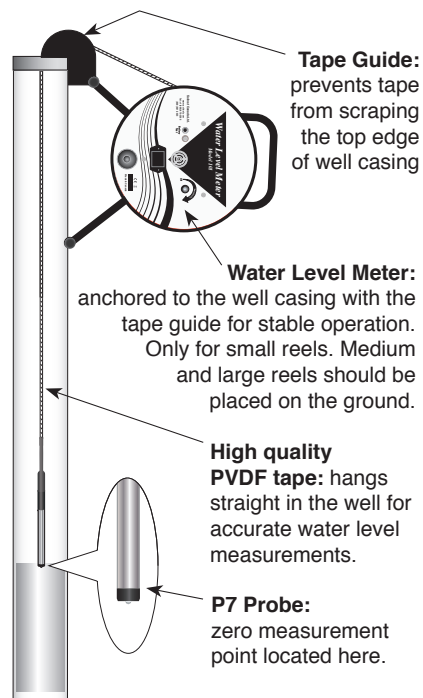

Water Level Measurements

1. The P7 Probe zero measurement point is located near the tip of the probe.
2. For ease of operation the Tape Guide can be used to support the Water Level Meter. (See diagram above).
3. Feed the tape into and out of the well using the groove in the top of the Tape Guide. The light and buzzer activate when the black Delrin tip is submerged and the zero point is reached. To ensure accuracy, lower and raise the probe a few times and then record the depth measurement from the tape at the top of the well.
4. When using the Tape Guide, the measuring point is offset from the top of casing. To adjust your measurements to the top of the casing, simply subtract the amount indicated on the front of the Tape Guide (i.e. 6 cm or 2/10 ft).

Routine Care

1. After the depth to water has been recorded, the tape should be carefully rewound onto the reel, the probe wiped dry and placed into the probe holder.
2. The probe, tape and reel can be cleaned with phosphate free (non-abrasive) detergent and warm water.
3. Use of a Water Level Meter Carrying Bag adds to the service life of the meter.
4. Use of the Tape Guide adds to the life of the tape.

Probe Care and Cleaning

1. The P7 Probe should be wiped clean after each use.
2. Remove any dirt or water from around the central sensor pin.
3. If the central sensor pin is corroded or coated, use emery cloth to polish it.
4. After cleaning, place probe back in its holder.

Battery Replacement

- Battery type - alkaline, 9 volt.
1. The battery is housed in a convenient battery drawer located in the faceplate of the Water Level Meter.
 2. To replace the battery, simply press the drawer in, lift then pull.
 3. The battery drawer should slide out of the faceplate enough to pull it out.
 4. Note the polarity (positive (+) terminal should be towards the small notch in the end of the drawer) and place new battery in the drawer and slide it back into the faceplate.

Replacement Parts

The following parts can be provided should they become lost or damaged.

1. Probes
2. Tape with Tape Seal Plug
3. Tape Seal Plug on shorter lengths of tape (3 ft or 1 m) and splice kit
4. Lights, switches, etc.
5. Reels

Troubleshooting

SYMPTOM	CAUSE	REMEDY
No sound when probe immersed in water.	Dead battery.	Replace with 9V Alkaline.
	Water Conductivity is very low.	Increase sensitivity switch setting (turn clockwise) or call Solinst for assistance.
	Disconnected wires on circuit board.	Check all connections inside hub for loose/disconnected wires - solder or reconnect.
	Broken wire in tape.	Locate break in tape - splice and seal. (Contact Solinst)
Instrument continuously sounds after being immersed in water.	Disconnected wire inside probe.	Contact Solinst to obtain parts/repair instructions.
	Water in probe. Probe may be dirty which could interfere with the circuit connection.	Disconnect P7 Probe. If sounding stops, check/replace o-ring. If sounding continues, check connection of electronics and wiring in reel. If sounding continues, contact Solinst for assessment or replace probe with new P7 probe.

Operation of the Controller

1. Set the speed dial on zero.
2. Connect to a 12V DC power supply using the clips provided.
3. Slowly turn the speed dial clockwise or counterclockwise until the motor just starts to turn.

Caution: Motor must be grounded in accordance with the national electrical code and local codes by trained personnel to prevent serious electrical shocks.

Ensure the air in-take fan at the end of the motor is clear.

If a down-hole component gets stuck, do not use power motor. To avoid injury, turn motor off immediately, and attempt retrieval manually.

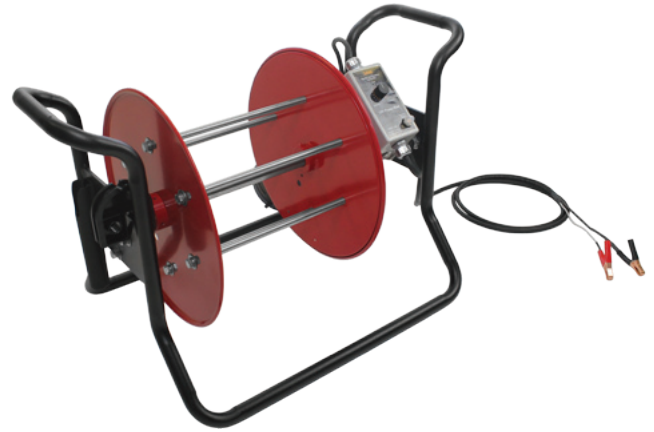

12V Power Reel without Tape, Cable, or Tubing on Reel

Lowering the Tape/Cable/Tubing

When lowering the tape/cable/tubing, the speed will be about 2 ft/s, increasing by about 2 ft/s for each additional 1000 ft of tape/cable/tubing down-hole. To reduce the speed increase during lowering, turn the speed dial down gradually. If the speed dial is at its lowest setting (1) and the speed is still too fast, decrease the speed by reversing the reel direction (i.e. rewind). This serves as a dynamic brake, and enables you to stop at the desired depth.

Retrieving the Tape/Cable/Tubing

When rewinding the tape/cable/tubing, the speed also depends on the length of tape/cable/tubing down-hole. At maximum depth (for longer lengths of 5000 ft down-hole), the speed will be about less than 0.2 ft/s, even at the maximum speed setting (8). The speed will gradually increase to about 2 ft/s as the tape/cable/tubing winds closer to the top of the well.

Controller

Input Ratings

10 - 16V DC @ 25A

Front Panel Controls

Speed dial: starts and stops motor, adjusts motor speed and direction of rotation

Reset: 25A rating

Ambient Temperature Conditions

Temperature: 0 - 40°C

Humidity: 90% RH or less, non-condensing

Motor

Lubrication

The shaft bearings contain grease fittings. After one year, insert multipurpose chassis grease, and re-apply once per year. The gear box is lubricated for life, and should never need to be lubed.

Servicing

Disconnect power source from motor and any accessory devices and allow motor to come to a complete stand still

Using the Tape Guide

Feed the tape/cable/tubing into and out of the well using the groove in the top of the Tape Guide.

The tape guide has been designed to:

- improve accuracy when reading water levels or depths,
- easily obtain repeatable measurements,
- prevent tape/cable/tubing being cut by well casing,
- allow the tape/cable/tubing to hang straight from the side of the well.

Tape Guide

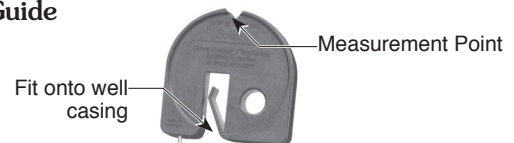

When using the tape guide for water level measurements, the measuring point is offset from the top of casing. To adjust your measurements to the top of the casing, simply subtract the amount indicated on the front of the tape guide (i.e. 6 cm or 2/10 ft.).

Tools and Materials Needed

1. Replacement Backplate Assembly (#103560, #105294, #105295, #104252-black)
 - Backplate (#103264, #104452, #104448, #104057-black)
 - 3 x Phillips Screws (#103485)
2. Robertson or Phillips Screwdriver
3. Retaining Ring Pliers

Instructions

1. Use the Phillips or Robertson screwdriver to undo the three screws holding the faceplate to the hub.
2. Remove the faceplate and disconnect the Molex connector that attaches the faceplate electronics to the tape/cable.

Note: There is no Molex connector to disconnect when replacing the backplate on a Model 103 Tag Line.

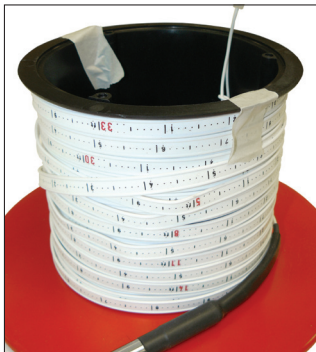

3. Secure the tape/cable so it does not slide off the reel.



4. Use the retaining ring pliers to remove the retaining ring holding the hub to the centre rod of the frame. Remove the three washers.

Note: Model 122 Interface Meters will have an additional washer over the centre rod that is connected to the ground cable. Remove this washer as well.



Red and Black Replacement Backplate Assemblies

5. Pull the hub and attached backplate from the frame.
6. Undo the three screws holding the backplate to the hub.
7. Secure the new backplate to the hub using the three screws.
8. Ensure the black delrin spacer is installed on the centre rod of the frame and the brake pad is flush with the back of the frame. Slide the hub and backplate back onto the frame.
9. Replace the three washers over the centre rod (nylon washer between the two stainless steel washers). Also reinstall the ground cable washer if replacing the backplate on a Model 122. Reinstall the retaining ring on the centre rod.

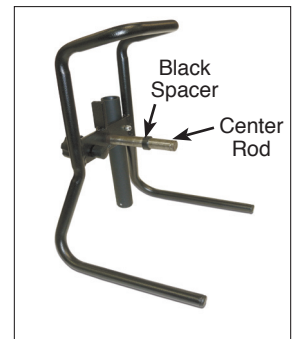

10. Connect the Molex connector from the faceplate to the tape/cable. (Not required for Model 103 replacements).
11. With the Probe in a glass of tap water, turn the Water Level Meter, Interface Meter or TLC Meter to the 'ON' position. If the connections are correct, the buzzer and light on the Meter will be activated. Check connections if the buzzer does not sound. (Not required for Model 103 replacements).
12. Replace the faceplate on the hub and re-secure the three screws.

Solinst® Battery Drawer Replacement

Model 101

Tools and Materials Needed

- 101 Replacement Battery Drawer Assembly (#103559), includes:
 - Single 9 Volt Battery Tray (#103308)
 - 2 x #4 x 1/2" Phillips Screws (#101712) for plastic reels
 - 2 x #4-40 x 1/2" Phillips Bolts (#100103) and 2 x #4-40 Nuts (#102154) for metal reels
- Phillips Screwdriver
- #4-40 Wrench (for metal reels)
- Wire Cutters and Strippers
- Soldering Wire and Iron
- 9 Volt Alkaline Battery (if required)



Instructions

1. Remove the battery drawer from the faceplate.

Note: To remove the battery drawer, press the drawer in, lift then pull. The battery drawer should slide out of the faceplate enough to pull it out and remove.

2. Undo the three screws from the front of the faceplate and remove the faceplate from the reel.
3. Undo the Molex connector that connects the faceplate electronics to the tape.
4. Cut the red and black wires from the back of the battery tray close to the terminals.
5. Undo the two screws (and nuts for metal reels) holding the battery tray in the faceplate. Remove the old battery tray.
6. Place the new battery tray through the faceplate and secure it with the two screws (and nuts where required).
7. Strip the red and black wires, cut from the old battery tray, about 1/4" (6 mm).
8. Solder the black wire to the negative terminal on the battery tray, and the red wire to the positive terminal. The terminals are labeled on the tray.
9. Note the polarity and place the battery in the new battery drawer. The positive terminal of the battery is placed towards the small notch in the end of the drawer.
10. Slide the battery drawer into the battery tray in the faceplate.
11. Reconnect the Molex connector from the faceplate electronics to the tape.
12. Use the three screws to replace the faceplate back on the reel.
13. With the Probe in a glass of tap water, turn the Water Level Meter to the 'ON' position. If the connections are correct the buzzer and light will activate. If the buzzer or light do not activate, check the polarity of the battery and Molex connector, and the soldered connections.

Tools and Materials Needed

1. Required Repair Kit
2. Small Flat Screwdriver (3 mm (1/10"))
3. 10 mm (3/8") Wrench
4. Wire Cutters
5. Wire Strippers
6. Solder Wire with Flux
7. Soldering Iron

Note: These instructions explain how to replace each electronic component, either all at once or separately as required. Overleaf are instructions to replace each component separately.

Replacing all Electronics

Complete Electronics Kit (#103558) Includes:

- Sensitivity Switch and Knob
- Test Button
- Red LED Indicator Light with Terminals
- Battery Tray and 2 Phillips Screws
- Circuit Board Assembly with Sonalert
- 9V Alkaline battery

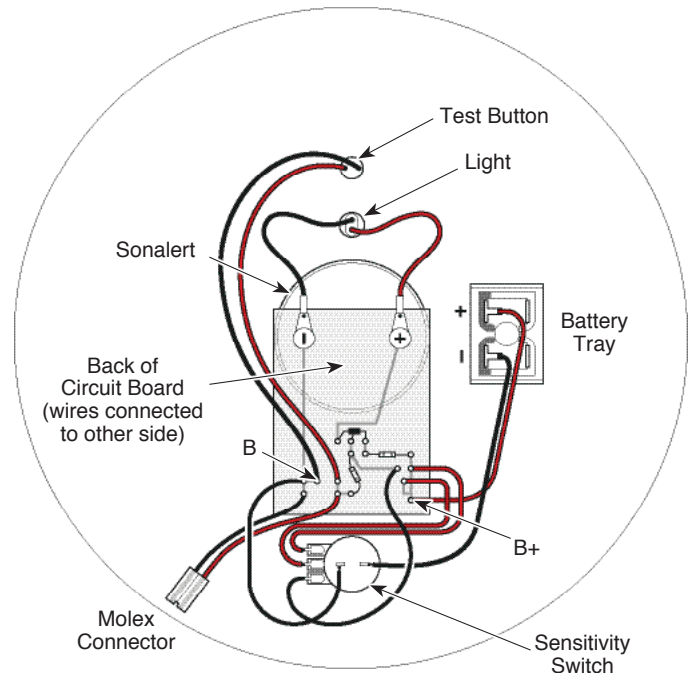

Circuit Board Showing Wire Connections

1. Remove the battery from the Meter. Undo the three screws holding the faceplate to the hub.
2. Remove the faceplate and disconnect the Molex connector connecting the circuit board to the tape.
3. From the front of the faceplate, unscrew the test button and push it out of the faceplate.
4. Push the light out of the faceplate.
5. Use the Phillips screwdriver to undo the two screws holding the battery tray to the faceplate. Cut the red and black wires from the back of the battery tray. Remove the battery tray.
6. Unscrew the Sonalert retaining ring from the front of the faceplate and remove the Sonalert and Circuit Board Assembly.
7. Use the small flat screwdriver to unscrew the small brass screw on the side of the sensitivity knob. Remove the sensitivity knob. Use the pliers to unscrew the nut holding the sensitivity switch and remove the switch from the faceplate.
8. Insert the new battery tray through the faceplate. Use the two screws to secure the tray to the faceplate.
9. Put the new Sonalert through the faceplate, and secure it using the retaining ring.
10. Install the new sensitivity switch, light, and test button in the faceplate.
11. Solder the wires from the new circuit board assembly to the correct connections on the test button, battery tray and sensitivity switch. Use steps 12 - 17, along with the diagram above, as a reference.
12. The red wire labeled B+ on the circuit board is connected to the positive terminal of the battery tray.

13. The other two red wires on the right side of the circuit board are connected to the first two connections on the sensitivity switch.
14. The black wire on the right side of the circuit board is connected to the third terminal on the sensitivity switch.
15. The black wire furthest left on the circuit board is attached to the terminal on the top of the sensitivity switch.

Note: There will be a black wire connecting the battery to the top of the sensitivity switch. The new circuit board assembly comes with a separate replacement wire.

16. The other black wire connected to the top of the sensitivity switch is connected to the negative terminal on the battery tray.
17. The red wire closest to the center of the circuit board is connected to the positive terminal of the test button, and the black wire labeled B on the circuit board is connected to the negative terminal on the test button.
18. Place the new circuit board assembly over the connections to the Sonalert and attach the wires from the light to the Sonalert using the two screws through the circuit board.
19. Connect the Molex connector from the new circuit board to connector on the tape. Install the new battery.
20. With the Probe in a glass of tap water, turn the Water Level Meter to the 'ON' position. If the connections are correct the buzzer and light will activate. If the buzzer or light do not activate, check the polarity of the battery and Molex connector, and the soldered connections.
21. Reattach the faceplate to the reel using the three screws.

Replacing the Circuit Board (#102977)

1. Remove the battery. Unscrew the three screws and remove the faceplate. Unplug the Molex connector from the circuit board to the tape.
2. Watch for proper connection/polarity on the Sonalert and remove the two screws to disconnect the old circuit board from the Sonalert and the wires connected to the light.
3. Cut the wires from the circuit board at the connections to the test button, sensitivity switch, and battery tray. Note the order/polarity in which they are connected. Remove the old circuit board assembly.
4. Solder the wires from the new circuit board assembly to the correct connections on the test button, battery tray and sensitivity switch. Use steps 12 - 17 overleaf, along with the diagram on the right, as a reference.
5. Place the new circuit board assembly over the connections to the Sonalert and reattach the wires from the light to the Sonalert using the two screws through the circuit board.
6. Connect the Molex connector from the new circuit board assembly to the connector on the tape.
7. Replace faceplate and re-fasten the three screws. Replace the battery.

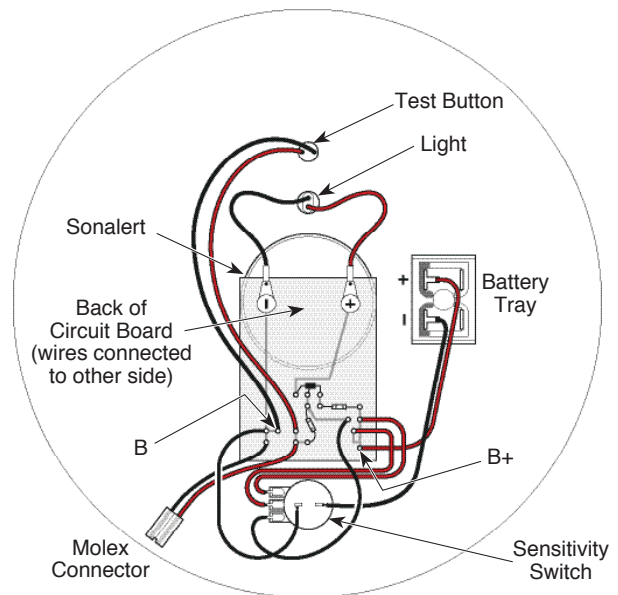

Circuit Board Showing Wire Connections

Replacing the Test Button (#109080)

1. Take out the battery, and remove the faceplate by unfastening the three screws.
2. Unplug the Molex connector from the circuit board to the tape.
3. Cut off the wires at the connections to the test button (note the polarity of the black and red wire) and strip the wires.
4. Unscrew the old test button and remove from the faceplate.
5. Screw in the new test button.
6. Attach the wires to the new test button by soldering.
7. Reconnect the Molex connector. Replace the faceplate by fastening the three screws. Replace the battery.

Replacing the On/Off Sensitivity Switch (#102976 or 110119)

1. Remove the battery.
2. Unscrew the small brass screw on the side of the sensitivity knob. Remove the sensitivity knob.
3. Unscrew and remove the faceplate. Unplug the Molex connector from the circuit board to the tape.

Note: To gain better access to the sensitivity switch, you may want to unscrew the two screws holding the circuit board to the Sonalert, in order to move the circuit board out of the way.

4. Cut and strip the wires at the connection to the sensitivity switch; note the order in which they are connected.
5. Unscrew the nut holding the sensitivity switch. Remove the switch from the faceplate.
6. Install the new sensitivity switch through the faceplate with the three connection prongs positioned opposite the battery drawer and slightly towards the centre of the reel. Tighten the nut.
7. Attach the wires to the correct positions by soldering. Use the diagram above as a reference.

8. Reconnect the Molex connector. Replace the faceplate, with three screws.
9. Fasten the sensitivity knob using the brass screw.
10. Replace the battery.

Replacing the Sonalert (#109075)

1. Remove the battery.
2. Unscrew the Sonalert retaining ring from the front of the faceplate. Push out the old Sonalert.
3. Unscrew and remove the faceplate. Unplug the Molex connector from the circuit board to the tape.
4. Unscrew the two screws holding the Sonalert to the circuit board (watch for proper connection/polarity). Remove the Sonalert from circuit board.
5. Insert the new Sonalert through the faceplate, and fasten the Sonalert retainer ring until finger tight. Screw the circuit board to the new Sonalert, making sure the wires from the light are connected.
6. Reconnect the Molex connector. Replace the faceplate using the three screws. Replace the battery.

Replacing the Light (#106660)

1. Remove the battery. Unscrew and remove the faceplate. Unplug the Molex connector from the circuit board to the tape.
2. Unscrew the two screws holding the wires from the light, through the circuit board and onto the Sonalert (watch for proper polarity).
3. Push the old light out and put the new light through the faceplate.
4. Reconnect the two wires, using screws through the circuit board and onto the Sonalert.
5. Reconnect the Molex connector. Replace faceplate using the three screws. Replace the battery.

Tools and Materials Needed

1. 101 Replacement Faceplate Assembly
 - Faceplate and Handle (without electronics)
 - 101 P2: #103565, #105299, or #105301
 - or 101 P7: #110502, #110503, or #110504
2. Phillips or Robertson (Square Head) Screwdriver
3. Small Flat Screwdriver
4. Needle Nose Pliers
5. Wire Strippers and Cutters
6. Soldering Iron and Wire

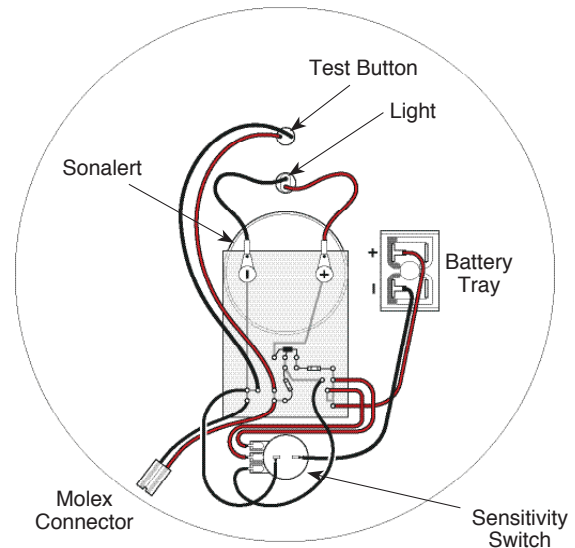

Back of 101 Faceplate showing wiring connections and the location of the components



101 P2 Replacement Faceplate Assembly indicating the location of the components (comes with Handle Assembly attached and 3 Phillips screws)

Instructions

1. Place the reel on a flat surface, with the faceplate up. Remove the battery from the Meter.
2. Use the Phillips or Robertson screwdriver to undo the three screws holding the faceplate to the hub.
3. Remove the faceplate and disconnect the Molex connector that attaches the faceplate electronics to the tape.
4. Unscrew the test button and push it out of the faceplate.
5. Unscrew the two screws holding the wires from the light, through the circuit board and onto the Sonalert (watch for proper polarity). Push the light out of the faceplate.
6. Use the small flat screwdriver to unscrew the small brass screw on the side of the sensitivity knob. Remove the sensitivity knob. Use the pliers to unscrew the nut holding the sensitivity switch and remove the switch from the faceplate.
7. Use the Phillips screwdriver to undo the two screws holding the battery tray to the faceplate. Cut the red and black wires from the back of the battery tray close to the terminals (other end of black wire is connected to the sensitivity switch, and red wire connects to the circuit board). Remove the battery tray. Strip the wires about 1/4" (6 mm).
8. Unscrew the Sonalert retaining ring from the front of the faceplate and remove the Sonalert.
9. Put the Sonalert through the new faceplate, and secure it using the retaining ring.
10. Replace the sensitivity switch, light, and test button in the new faceplate.
11. Reconnect the two wires, from the light, using the two screws through the circuit board and onto the Sonalert.
12. Insert the battery tray through the new faceplate. Re-solder the red and black wires to the correct terminals labeled on the back of the battery tray. Red wire from the circuit board to the positive terminal and black wire from sensitivity switch to the negative terminal. Use the two screws to secure the tray to the faceplate.
13. Connect the Molex connector from the faceplate to the tape.
14. With the Probe in a glass of tap water, turn the Water Level Meter to the 'ON' position. If the connections are correct the buzzer and light will activate. If the buzzer or light do not activate, check the polarity of the battery and Molex connector, and the soldered connections.
15. Screw the new faceplate to the reel using the new Phillips screws, and replace the battery.

Tools and Materials Needed

- Required Replacement Part
 - Frame Assembly (#103562, #105292, or #105293)
 - Frame with Caps (#102160, #103337, or #103338 with #102161)
 - Black Delrin Spacer (#102163)
 - Brake Assembly (#103564)
 - Brake Knob (#102158)
 - Brake Pad (#103273)
 - Probe Holder Assembly (#102978)
 - Probe Holder (#104957)
 - #10-32 x 5/8" Allen Screw (#100052)
 - #10-32 Nylock Nut (#100053)
- Phillips Screwdriver
- Retaining Ring Pliers
- 1/4" (6.4 mm) Wrench or Pliers
- 1/4" (6.4 mm) Allen Key

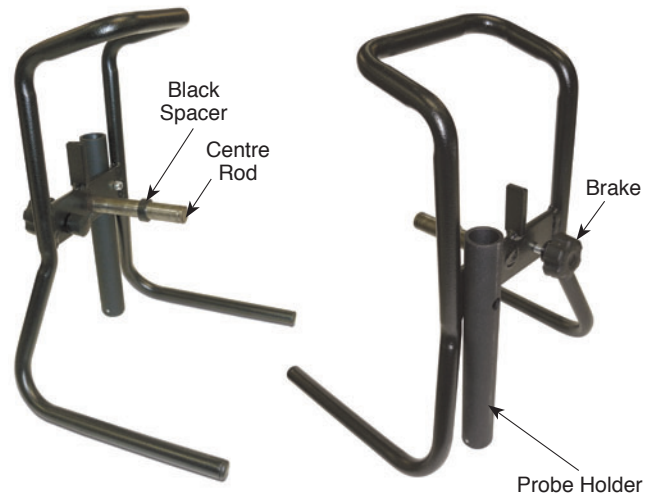

101 Frame Assembly

Replacing the Frame

- Use the Phillips or Robertson screwdriver to undo the three screws holding the faceplate to the hub.
- Remove the faceplate and disconnect the Molex connector that attaches the faceplate electronics to the tape. Secure the tape to the hub so it does not uncoil when you are removing the hub.
- Use the retaining ring pliers to remove the retaining ring holding the hub to the centre rod of the frame. Remove the three washers.



- Pull the hub and backplate from the frame.
- Insert the brake knob through the opening provided in the back of the new frame. Stabilize the brake knob, and screw the pad onto the knob.
- Attach the probe holder to the frame. (See "Replacing Probe Holder" at right.)
- Ensure the black delrin spacer is installed on the centre rod of the new frame and the brake is tightened so the pad is flush with the back of the frame. Slide the hub and backplate back onto the new frame.
- Replace the three washers over the centre rod (nylon washer between the two stainless steel washers) and reinstall the retaining ring on the centre rod.
- Connect the Molex connector from the faceplate to the tape.
- Replace the faceplate on the hub and re-secure the three screws.

Replacing the Brake

- Following steps 1-4 at left remove and disconnect the faceplate from the hub, and remove the hub and backplate from the frame.
- Hold the brake pad and unscrew the knob from the pad. Remove the brake from the frame.
- Insert the new brake knob through the opening in the frame.
- Stabilize the new brake pad, and screw the knob into the pad.
- Following steps 7-10 at left replace the backplate and hub back onto the frame and the faceplate back onto the hub.



Replacing the Probe Holder

- Following steps 1 - 4 at left (see "Replacing the Frame"), remove and disconnect the faceplate from the hub, and remove the hub and backplate from the frame.
- Insert an Allen key through the hole in the back of the probe holder to stabilize the screw. Use the wrench to remove the nut. Remove the old probe holder.
- Align the hole in the new probe holder with the opening in the frame. Insert the screw through the hole in the probe holder and the frame.
- Insert the Allen key through the hole in the probe holder to stabilize the screw.
- Use the wrench to tighten the knob and secure the new probe holder to the frame.
- Following steps 7-10 at left (see "Replacing the Frame"), replace the backplate and hub back onto the frame and the faceplate back onto the hub.



®Solinst is a registered trademark of Solinst Canada Ltd.

Laser Marked PVDF Flat Tape Accuracy Statement

Solinst #101 P7 Water Level Meters and 107 TLC Meters are certified traceable to National Standards.

Our reference standard is verified by the **NIST Metrology Laboratory** (National Institute of Standards and Technology). NIST Test # 821/278129-09

Accuracy specifications of our marked flat tapes meets or exceeds tolerances outlined in the following international standards :

EU Measurement Instruments Directive 2004/22/EC, Accuracy Class I, (European Union Standard)

ASME Performance Standard for Steel Measuring Tapes: B89.1.7-2009

NIST Handbook 44, Section 5.52, "Linear Tolerances", (North American Standard).

Specifically, all Solinst PVDF Flat Tapes are marked to an accuracy of at least 0.01%, under horizontal tension using a 500g (17.6 ounce) weight.

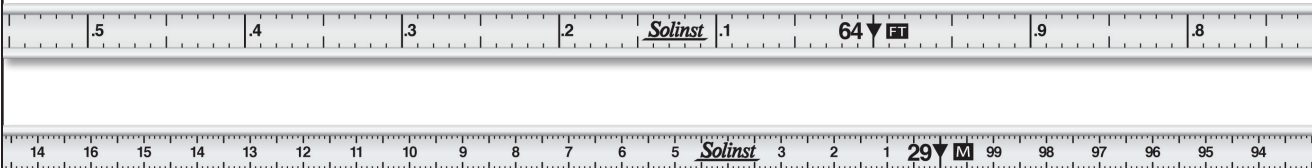

The PVDF Flat Tape is Laser-marked every 1/100ft or each millimeter

Solinst Flat Tape Specifications:

- Break Strength: >100Kg (220 lbs)
- SS Conductors coefficient of linear thermal expansion: $16 \times 10^{-6} K^{-1}$
- 13 strands of 304 Stainless Steel and 6 strands of copper-coated steel in each conductor
- PVDF flat tape jacket

Solinst® Connecting PVDF Laser Replacement Tape to Reel

Model 101 P7/107/122

Tools and Materials Needed

- Model 101 P7/107/122 Replacement Laser Tape Assembly, Includes:
 - Jumper Cable (New Tape - 3 Pin to 2 Pin) (#110508)
 - 3 Pin Molex Connector Housing
 - Grommet
- Phillips or Robertson Screwdriver
- Wire Cutters

Note: The Jumper Cable is only required if you are connecting the new Laser Tape to a Model 101 Water Level Meter that previously used polyethylene tape (with red ft/m markings). The Molex Connector from the faceplate electronics will have a 2 pin connection.

Instructions

- Place the reel on a flat workbench with the faceplate up. Undo the three screws from the faceplate, and slowly remove it from the reel.
- Disconnect the old Tape Molex Connector from the Faceplate Molex Connector.

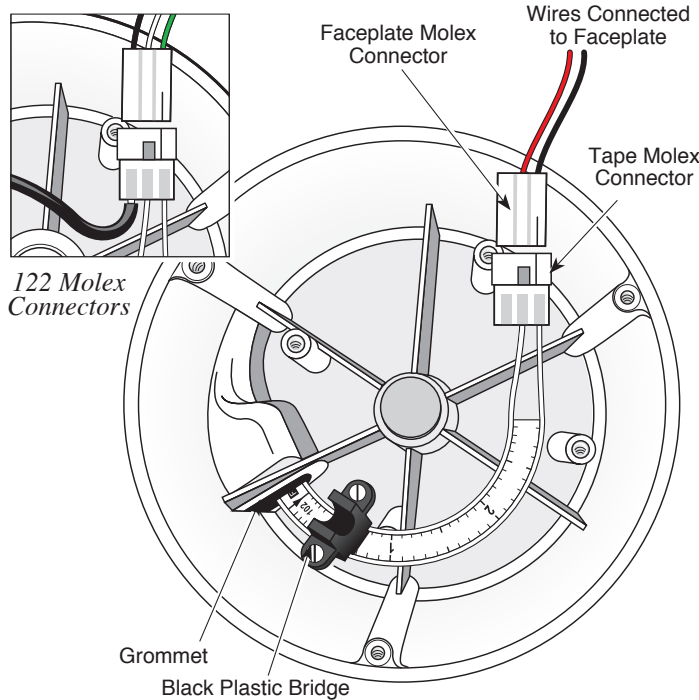

Inside View of 101 P7/107 Reel Hub

- Undo the two screws from the black plastic bridge holding the tape inside the reel hub, and remove the top piece of the bridge.

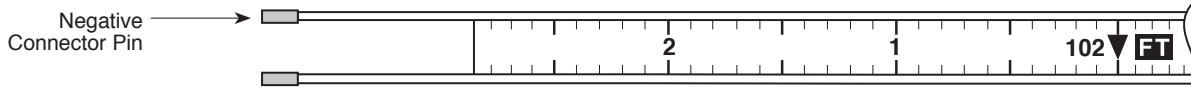

- Use the wire cutters to cut the old Tape Molex Connector from the old tape. Remove the ground wire from the 122 Tape Molex connector by pushing out the pin. Pull the old tape through the grommet and remove it from the reel.
- Feed the new Laser Tape through the grommet into the reel hub.

Note: The replacement tape comes with a new grommet. The old grommet may be replaced with the new one, or left in if not damaged.

- By hand, insert the connector pins into the new Tape Molex Connector housing. The negative connector pin is inserted into the terminal on the pointed side of the Tape Molex Connector, housing and the positive pin into the middle terminal. The negative pin is above the numbers on the tape (see diagram at the bottom of the page). The third terminal is left open for the 107 and 101 P7, the ground wire is inserted for the 122.
- Position the tape inside the reel hub with black plastic bridge over top and refasten the two screws to secure the tape to the reel.
- Connect the Tape Molex Connector to the Faceplate Molex Connector.

Note: If you are connecting the Laser Tape to a Model 101 that previously used polyethylene tape, you will need to use the Jumper Cable. Attach the 3 pin connection to the Tape Molex Connector, and the 2 pin connection to the Faceplate Molex Connector.

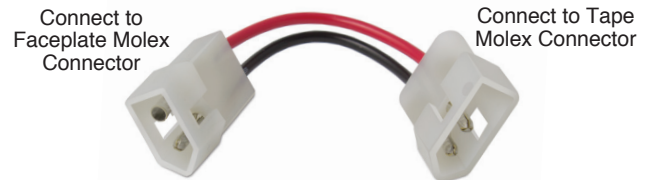

Jumper Cable (New Tape - 3 Pin to 2 Pin) (#110508)

- Attach the probe to the tape seal (existing or replacement probe). **See separate probe replacement instructions.**

Notes: The Model 107 probe comes factory calibrated, so there is no need to conduct a user calibration. If with time, recalibration is required, please refer to the Model 107 TLC Meter Operating Instructions.

- 101 P7/107:** With the probe in a glass of tap water, turn the Meter 'ON'. If the buzzer or light do not activate, or the Model 107 LCD does not show temperature or conductivity, check the probe and tape connections.

122: With the Probe in a glass of tap water and product, turn the Interface Meter to the 'ON' position. A steady tone and light indicates a product, while an intermittent tone indicates water. If the buzzer or light do not activate, check the probe and tape connections

- Replace the faceplate on the reel and re-secure the three screws.
- Slowly wind the tape onto the reel, holding to ensure no slack.

®Solinst is a registered trademark of Solinst Canada Ltd.

Printed in Canada
January 2, 2014
(#110225)

For further information contact: Solinst Canada Ltd.
Fax: +1 (905) 873-1992; (800) 516-9081 Tel: +1 (905) 873-2255; (800) 661-2023
35 Todd Road, Georgetown, Ontario Canada L7G 4R8
Web Site: www.solinst.com E-mail: instruments@solinst.com

Solinst®

The Accuracy of Solinst Flat Tape

All of the tapes used for Solinst Model 101 P2 Water Level Meter, Model 122 and 122M Interface Meters are marked to the following standard:

During the marking process a load of 5 kg (11 lbs) is applied to the tape, which is horizontal. A steel calibrated measure, 20 metres in length, is used to check the accuracy of the markings. The acceptable tolerance is +2 to +8 mm [i.e. +/- 0.015% from the mean tolerance of +5 mm (+0.197")].

This method has been found to give the best accuracy in normal use (i.e. average tape length and life span). When the probe is attached to the tape, the zero point of the measurement is taken from the tip of the central electrode.

The steel calibration measure used to check our tape markings is 20 metres long and has been verified by measurements traceable to National Standards to be +2.3 mm longer than the exact measure (with an uncertainty of +/- 0.2 mm). This difference is taken into account in the marking of our tapes.

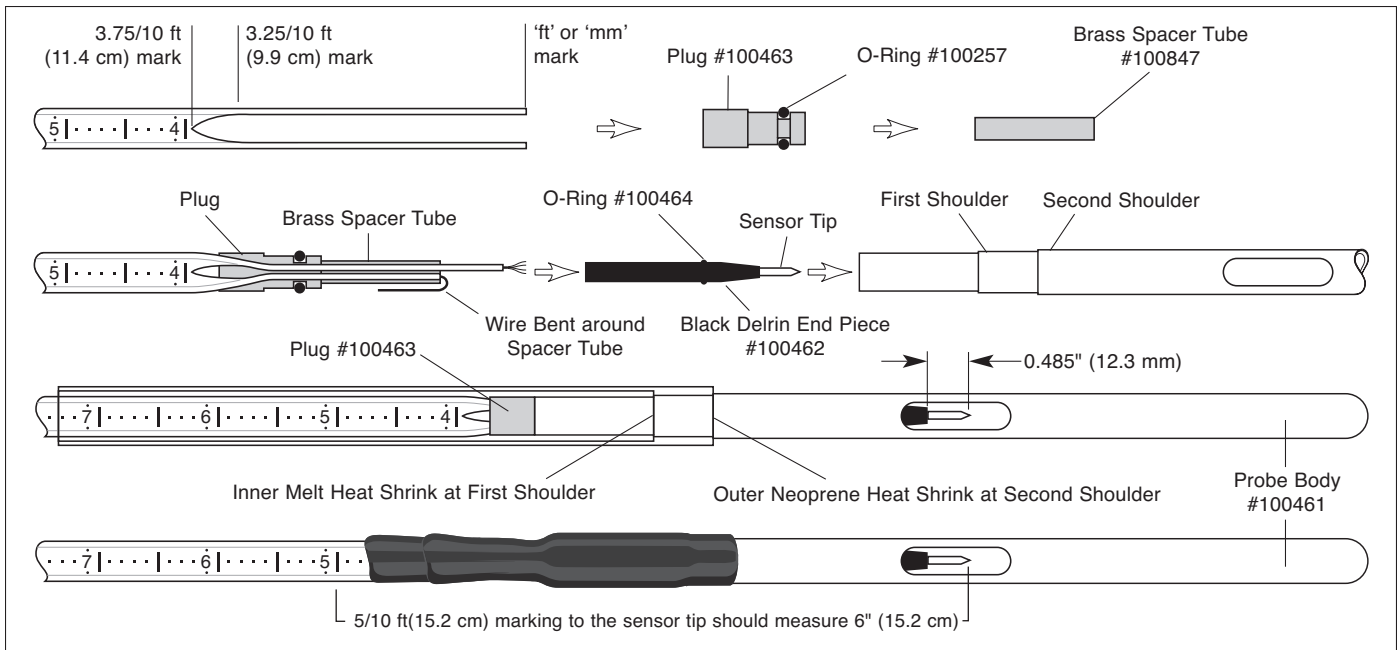

Tools and Materials Needed

1. P2 SS Probe with Seal Kit (#102979)
2. Embossed Flat Tape
3. Wire Cutter
4. Wire Stripper
5. Heat Gun



Instructions

Note: These instructions refer to a tape with 1/10 ft markings NOT inches. Metric conversions are provided in brackets.

1. Cut tape at point zero ("ft" or "mm" mark). Cut along the lead wires from point zero to the 3.25/10 ft (9.9 cm) mark on the tape. Cut in a triangle formation pointing to the 3.75/10 ft (11.4 cm) mark.
2. Thread the two wires from the flat tape through the plug.
3. Thread both wires into the brass spacer tube.
4. Cut one wire 1/2" (1.2 cm) longer than the brass spacer tube, as shown in the diagram. Strip that wire from the end of the brass spacer tube. Bend the stripped wire over the brass spacer tube.
5. Measure the other wire to extend just past the o-ring on the end piece and cut. Strip approximately 1/4" (6 mm) of this wire, and twist the wire loose. Twist the end piece onto this wire, down to the brass spacer tube.

Note: The sensor tip must be positioned correctly to give accurate measurements. It will take some force to get the sensor tip positioned correctly, a jig or clamps may help.

6. Insert the wedge end of the sensor tip into the tapered end of the end piece. To ensure the sensor tip is positioned at the correct zero point, push the sensor tip into the end piece until, when measured, the distance between the 5/10 ft (15.2 cm) marking on the tape and the sensor tip is 6" (15.2 cm). The shoulder of the end piece to the end of the sensor tip should measure 0.485" (12.3 mm), to ensure correct measurements.
7. As you push the inner components into the probe body twist the probe gently to fit over the o-rings (some vaseline on the o-rings helps ease the probe on).

Note: Be careful not to melt the tape with the heat gun

8. Slip the inner melt heat shrink (round heat shrink) over the probe onto the flat tape, and against the first shoulder on the probe body. Apply heat starting from the center working outward, pressing the heat shrink on tape with fingers to smooth out.
9. Slip the outer neoprene heat shrink (flat heat shrink) over the inner melt heat shrink against the second shoulder on the probe body. Apply heat starting from the center working outward. Press the heat shrink onto the tape with your fingers.

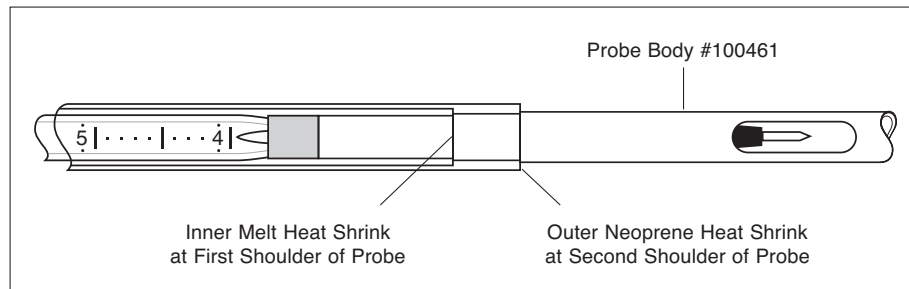

Tools and Material Needed

1. Probe Seal Kit (#102795)
 - 5" (130 mm) piece of Inner Melt Heat Shrink
 - 5" (130 mm) piece of Neoprene Heat Shrink
2. Heat Gun

Note: The inner melt heat shrink will make a clicking noise when the end is pinched together and is rounder and slightly darker in colour.

Instructions

1. Slide the inner melt heat shrink over the probe, lining up the end of the heat shrink with the first shoulder on the probe body (see diagram).
2. Use a heat gun and apply heat starting at the shoulder of the probe and working towards the tape to prevent air pockets from forming. Heat until only a slight amount of inner melt shows from the end of the heat shrink.
3. Gently press the heat shrink onto the tape with your fingers. Let cool.
4. Slide the outer neoprene heat shrink over the probe, lining up the end of the heat shrink with the second shoulder on the probe body.
5. Apply heat starting at the shoulder of the probe working towards the tape.
6. Gently press the heat shrink onto the tape with your fingers.

Note: Be careful not to melt the tape with the heat gun.

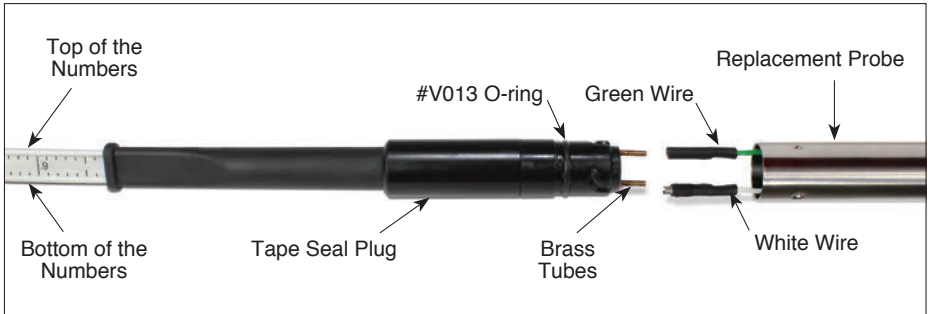

Tools and Materials Needed

1. 101 P7 Replacement Probe Assembly (#110483)
 - Includes replacement #V013 O-Ring
2. Tweezers

Instructions

1. Make sure the Water Level Meter is turned off.
2. To remove the old probe, twist the probe counter-clockwise and pull out. This may take some force.
3. Remove the two connectors from the brass tubes.
4. Lay the tape and tape seal plug so the numbers on the tape are facing up. Ensure there is an o-ring on the tape seal plug.
5. Use tweezers to carefully pull the green and white wire connectors from the replacement probe body.
6. To attach the new probe, connect the green wire to the brass connector on the top of the tape seal plug and the white wire to the bottom brass tube.
7. Line up the indents in the probe with the grooves in the tape seal plug. Push the probe past the o-ring, then twist the probe clockwise until the probe seats on the tape seal plug.
8. With the Probe in a glass of tap water, turn the Water Level Meter to the 'ON' position. If the connections are correct, the buzzer and light on the Meter will be activated. Check connections if the buzzer does not sound.

Note: Make sure the wires are tucked back into the probe body when pushing the probe onto the tape seal plug.

®Solinst is a registered trademark of Solinst Canada Ltd.

Solinst® Water Level Meter - 12V Power Reel Instructions

Model 101

Operation of the Controller

1. Set the 'Speed' dial on zero.
2. Connect to a 12V DC power supply using the clips provided.
3. Slowly turn the 'Speed' dial clockwise until the motor just starts to turn.

Caution: Motor must be grounded in accordance with the national electrical code and local codes by trained personnel to prevent serious electrical shocks.

If down-hole component gets stuck, do not use power motor. To avoid injury, turn motor off immediately, and attempt retrieval manually.



Note:

The Power Reel can use heat embossed polyethylene flat tape or Solinst laser-marked flat tape.

Controller

Input Ratings

10 - 16V DC @ 25A

Front Panel Controls

Integral Fwd/Rev speed dial

Reset: 25A rating

Ambient Temperature Conditions

Temperature: 0 - 40°C

Humidity: 90% RH or less, non-condensing

Motor

Lubrication

The shaft bearings contain grease fittings. After one year, insert multipurpose chassis grease, and re-apply once per year. The gear box is lubricated for life, and should never need to be lubed.

Servicing

Disconnect power source from motor and any accessory devices and allow motor to come to a complete stand still.

Water Level Meter Operation

Equipment Check

1. The level of sensitivity can be adjusted higher or lower by turning the dial clockwise or counter clockwise, and pressing the sensitivity button.
2. Depress the Battery Test button to test the battery and circuitry.
3. Submerge the probe in tap water. This completes the circuit and activates the buzzer and light.

Water Level Measurement

The zero measurement point is at the tip of the sensor pin, located at the centre of the P2 Probes, and where the black Delrin tip meets the stainless steel body of the P7 Probes.

The light and buzzer activate when the zero point enters water. To ensure accuracy, lower and raise the probe a few times and then record the depth measurement from the tape at the top of the well.

Using the Tape Guide

The tape guide has been designed to:

- improve accuracy when reading water levels,
- easily obtain repeatable measurements,
- prevent tape being cut by well casing,
- allow the tape and probe to hang straight from the side of the well.

Operation

Feed the tape into and out of the well using the groove in the top of the Tape Guide.

Tape Guide



When using the tape guide, the measuring point is offset from the top of casing. To adjust your measurements to the top of the casing, simply subtract the amount indicated on the front of the tape guide (i.e. 6 cm or 2/10 ft.).

Routine Care

1. After the depth to water has been recorded, the tape should be carefully rewound onto the reel, the probe wiped dry and placed into the probe holder.
2. The probe, tape and reel can be cleaned with phosphate free (non-abrasive) detergent and warm water.
3. Remove any dirt or water from around the central sensor pin. If the central sensor pin is corroded or coated, use emery cloth to polish it.
4. Check the P2 probe seal/strain relief and replace the black heat shrink if there is any cracking or other damage.
5. Use of the Tape Guide adds to the life of the tape.

Battery Replacement (battery type - alkaline, 9 volt.)

1. The battery is housed conveniently on the front of the box with the sensitivity switch.
2. To replace the battery, open the compartment with a screw driver.
3. Note the polarity and place another new battery in the drawer and slide it back into the faceplate.

Replacement Parts

The following parts can be provided should they become lost or damaged: Probes and seal kits, splice kits, lights, switches, etc., reels, and replacement tape with probes (complete) or probe seals.

SYMPTOM	CAUSE	REMEDY
No sound when probe immersed in water	Dead battery.	Replace with 9V Alkaline.
	Water conductivity is very low.	Increase sensitivity switch setting (turn clockwise) or call Solinst for assistance.
	Disconnected wires on circuit board.	Check all connections inside hub of reel for loose/disconnected wires - solder or reconnect.
	Broken wire in tape.	Locate break in tape - splice and seal (contact Solinst).
	Disconnected wire inside probe.	Contact Solinst to obtain parts/repair instructions.

® Solinst is a registered trademark of Solinst Canada Ltd

Printed in Canada
February 27, 2012
(#109462)

For further information contact: Solinst Canada Ltd.
Fax: +1 (905) 873-1992; (800) 516-9081 Tel: +1 (905) 873-2255; (800) 661-2023
35 Todd Road, Georgetown, Ontario Canada L7G 4R8
Web Site: www.solinst.com E-mail: instruments@solinst.com

Solinst®

Solinst® Water Level Meter - 110V Power Reel Instructions

Model 101

Operation of the Controller

1. Ensure that the 'FWD/OFF/REV' switch is in the 'OFF' position.
2. Set the 'Speed' potentiometer on zero.
3. Connect AC line power.
4. Select FWD or REV.
5. Slowly turn the 'Speed' potentiometer clockwise until the motor just starts to turn.

Caution: Motor must be grounded in accordance with the national electrical code and local codes by trained personnel to prevent serious electrical shocks.

If down-hole component gets stuck, do not use power motor. To avoid injury, turn motor off immediately, and attempt retrieval manually.

Note: The Power Reel can use heat embossed polyethylene flat tape or Solinst laser-marked flat tape



Controller

Input Ratings

Voltage: 115V AC single phase +/- 10%
(220V Power Reel: 125V AC single phase +/- 10%)

Frequency: 50/60Hz +/- 2Hz

Front Panel Controls

Speed Pot: Adjusts motor speed from MIN SPD (0) setting to MAX SPD (10) setting.

FWD/STOP/REV: Starts and Stops motor, selects motor rotation.

Ambient Temperature Conditions

Temperature: 0 - 40°C

Humidity: 90% RH or less, non-condensing

Motor

Lubrication

The shaft bearings contain grease fittings. After one year, insert multipurpose chassis grease, and re-apply once per year. The gear box is lubricated for life, and should never need to be lubed.

Servicing

Disconnect power source from motor and any accessory devices and allow motor to come to a complete stand still.

Water Level Meter Operation

Equipment Check

1. The level of sensitivity can be adjusted higher or lower by turning the dial clockwise or counter clockwise, and pressing the sensitivity button.
2. Depress the Battery Test button to test the battery and circuitry.
3. Submerge the probe in tap water. This completes the circuit and activates the buzzer and light.

Water Level Measurement

The zero measurement point is at the tip of the sensor pin, located at the centre of the P2 Probes, and where the black Delrin tip meets the stainless steel body of the P7 Probes.

The light and buzzer activate when the zero point enters water. To ensure accuracy, lower and raise the probe a few times and then record the depth measurement from the tape at the top of the well.

Using the Tape Guide

The tape guide has been designed to:

- improve accuracy when reading water levels,
- easily obtain repeatable measurements,
- prevent tape being cut by well casing,
- allow the tape and probe to hang straight from the side of the well.

Operation

Feed the tape into and out of the well using the groove in the top of the Tape Guide.

Tape Guide



When using the tape guide, the measuring point is offset from the top of casing. To adjust your measurements to the top of the casing, simply subtract the amount indicated on the front of the tape guide (i.e. 6 cm or 2/10 ft.).

Routine Care

1. After the depth to water has been recorded, the tape should be carefully rewound onto the reel, the probe wiped dry and placed into the probe holder.
2. The probe, tape and reel can be cleaned with phosphate free (non-abrasive) detergent and warm water.
3. Remove any dirt or water from around the central sensor pin. If the central sensor pin is corroded or coated, use emery cloth to polish it.
4. Check the P2 probe seal/strain relief and replace the black heat shrink if there is any cracking or other damage.
5. Use of the Tape Guide adds to the life of the tape.

Battery Replacement (battery type - alkaline, 9 volt.)

1. The battery is housed conveniently on the front of the box with the sensitivity switch.
2. To replace the battery, open the compartment with a screw driver.
3. Note the polarity and place another new battery in the drawer and slide it back into the faceplate.

Replacement Parts

The following parts can be provided should they become lost or damaged: Probes and seal kits, splice kits, lights, switches, etc., reels, and replacement tapes with probes (complete) or probe seals.

SYMPTOM	CAUSE	REMEDY
No sound when probe immersed in water	Dead battery.	Replace with 9V Alkaline.
	Water conductivity is very low.	Increase sensitivity switch setting (turn clockwise) or call Solinst for assistance.
	Disconnected wires on circuit board.	Check all connections inside hub of reel for loose/disconnected wires - solder or reconnect.
	Broken wire in tape.	Locate break in tape - splice and seal (contact Solinst).
	Disconnected wire inside probe.	Contact Solinst to obtain parts/repair instructions.

® Solinst is a registered trademark of Solinst Canada Ltd

Printed in Canada
February 27, 2012
(#109338)

For further information contact: Solinst Canada Ltd.
Fax: +1 (905) 873-1992; (800) 516-9081 Tel: +1 (905) 873-2255; (800) 661-2023
35 Todd Road, Georgetown, Ontario Canada L7G 4R8
Web Site: www.solinst.com E-mail: instruments@solinst.com

Solinst®

Tools and Materials Needed

1. 101 Power Reel Water Level Meter Electronics Assembly (Spare) (#110547)
2. Wire Cutters
3. Phillips Screwdriver
4. 1/8" Allen Key
5. 3/8" Hex or Socket Wrench
6. Flat Screwdriver

2. Unwind the entire tape from the reel.
3. Unplug the Molex connector that connects the tape to the Water Level Meter electronics.
4. Cut the Molex connector off the wires of the old Water Level Meter electronics (Molex connector will not fit through the grommet).
5. Use the Phillips screwdriver to remove the four screws from the corners of the front plate of the electronics enclosure, and remove it from the reel.

Remove four corner screws



6. Remove the two screws holding the back plate of the enclosure to the reel. Stabilize the nuts with the socket or hex wrench, while using the Allen key to undo the screws.
7. Push out to remove the grommet from the reel and back plate. A new grommet is provided with the replacement assembly.

Secure two screws with washers, then nuts

Grommet

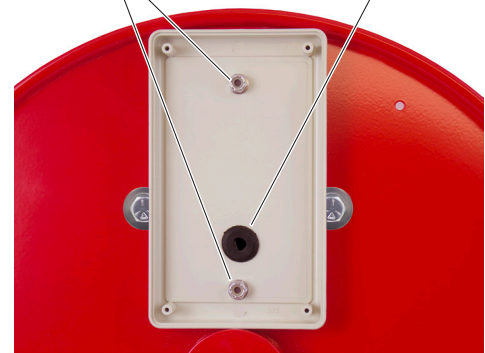

8. Use the Phillips screwdriver to remove the four screws from the corners of the new electronics enclosure to separate the front plate from the back plate.
9. Mount the back plate of the new electronics enclosure onto the reel, in the same position as the old enclosure. Use the two new screws from the inside of the reel, with washers then the nuts on the inside of the back plate to secure it to the reel.
10. Insert the new grommet into the hole, so that it straddles the reel and the back plate of the enclosure. Use the flat screwdriver to help get the grommet in place.

Continued overleaf...

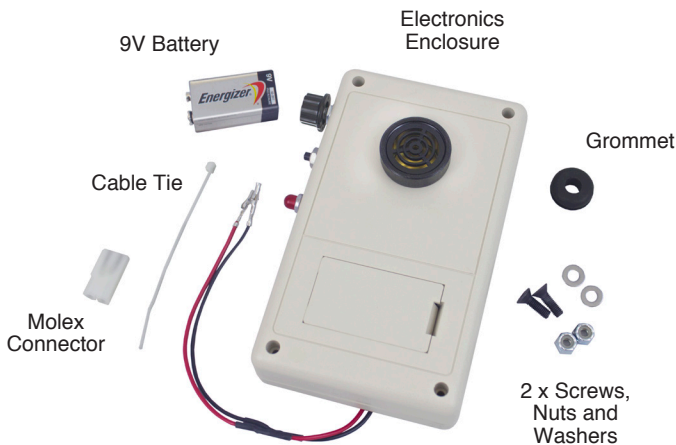

101 Power Reel Water Level Meter Electronics Assembly

Instructions

1. Disconnect the Power Reel from the power source, and remove the battery from the Water Level Meter electronics enclosure.

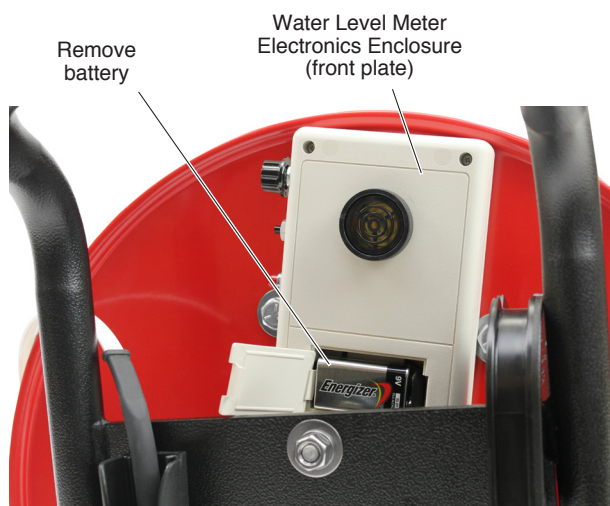

11. Insert the wires from the front plate of the new electronics, through the grommet and into the reel hub.
12. Use the four new screws to secure the front plate to the back plate of the Water Level Meter electronics enclosure.
13. Insert the two wires from the Water Level Meter electronics into the new Molex connector. The negative connector pin (black wire) is inserted into the terminal on the pointed side of the Molex connector, and the positive pin (red wire) into the other terminal.
14. Use the cable tie to secure the wires with the Molex connector to one of the spokes in the reel.

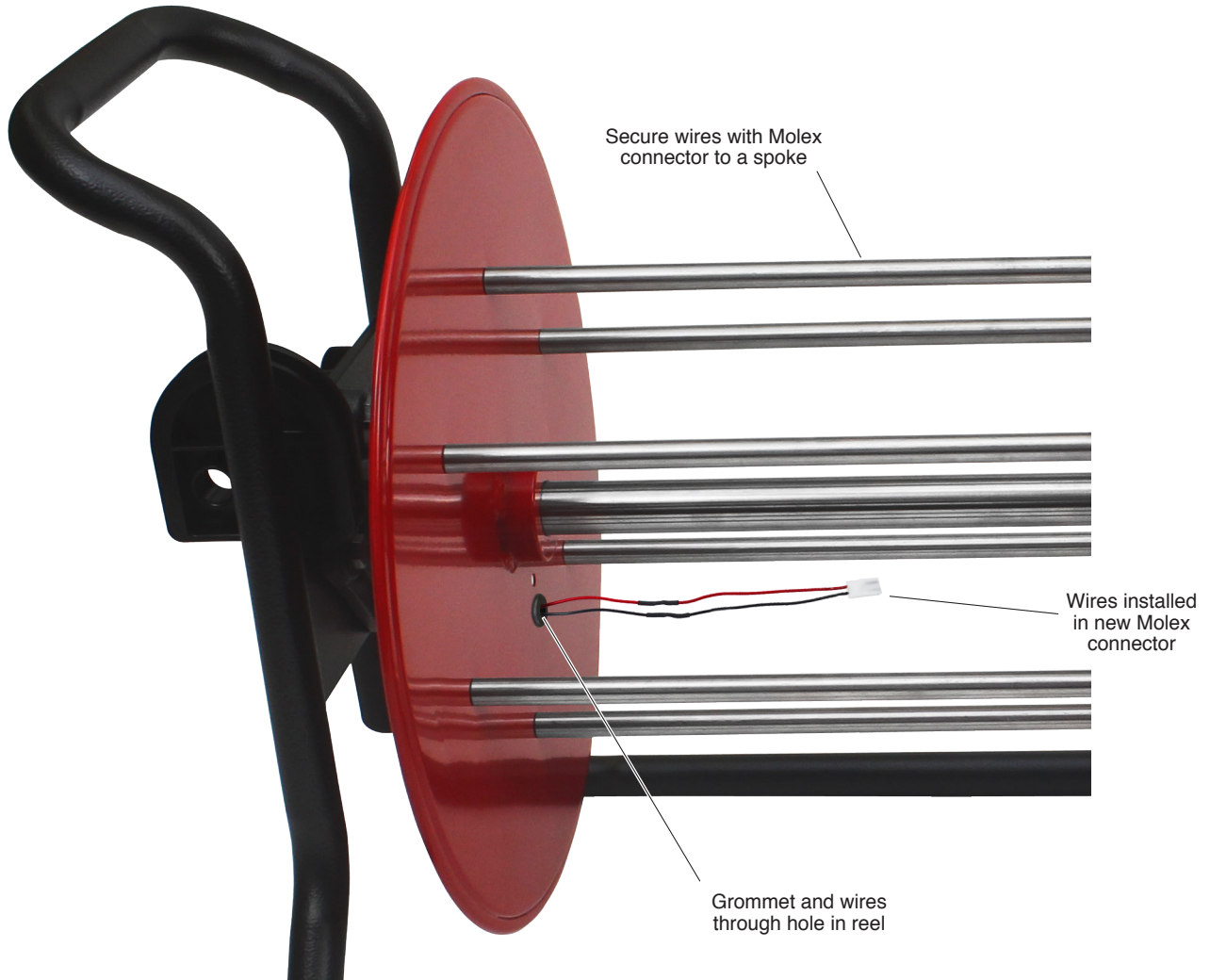

15. Connect the new electronics Molex connector to the Molex connector on the tape.
16. Before winding the tape back onto the reel, test the Water Level Meter electronics by turning the meter on using the dial, and pressing the black test button. The light and buzzer (Sonalert) should activate. Check the connections if the buzzer and light do not work.
17. Wind the tape back onto the reel. Install the new 9V battery.

[®]Solinst is a registered trademark of Solinst Canada Ltd.

Solinst® Connecting Polyethylene Replacement Tape to Reel

Model 101 P2

Tools and Materials Needed

1. Model 101 P2 Replacement Tape Assembly
 - Comes with P2 Probe attached
 - 2 Pin Molex Connector
 - Grommet
2. Phillips or Robertson Screwdriver
3. Wire Cutters

Instructions

1. Place Reel on a flat workbench with Faceplate up. Undo the three screws from the Faceplate, and slowly remove it from the Reel.
2. Disconnect old Tape Molex Connector from the Faceplate Molex Connector.
3. Undo the two screws from the Black Plastic Bridge holding the Tape inside the Reel Hub, and remove the top piece of the bridge.
4. Use the wire cutters to cut the old Tape Molex Connector from the old Tape. Pull the old Tape through the Grommet and remove from the Reel.

Note: The Replacement Tape comes with a new Grommet. The old Grommet may be replaced with the new one, or left in if not damaged.

5. Feed the new Tape with Connector Pins through the Grommet into the Reel Hub.

Note: There is a knot and a black band on the wire indicating the negative Connector Pin.

6. By hand, insert the Connector Pins into the new Tape Molex Connector. The Negative Connector Pin is inserted into the terminal on the pointed side of the Tape Molex Connector, and the Positive Pin into the other terminal
7. Position the Tape inside the Reel Hub with Black Plastic Bridge over top (see diagram above). Refasten the two screws to secure the Tape to the Reel.

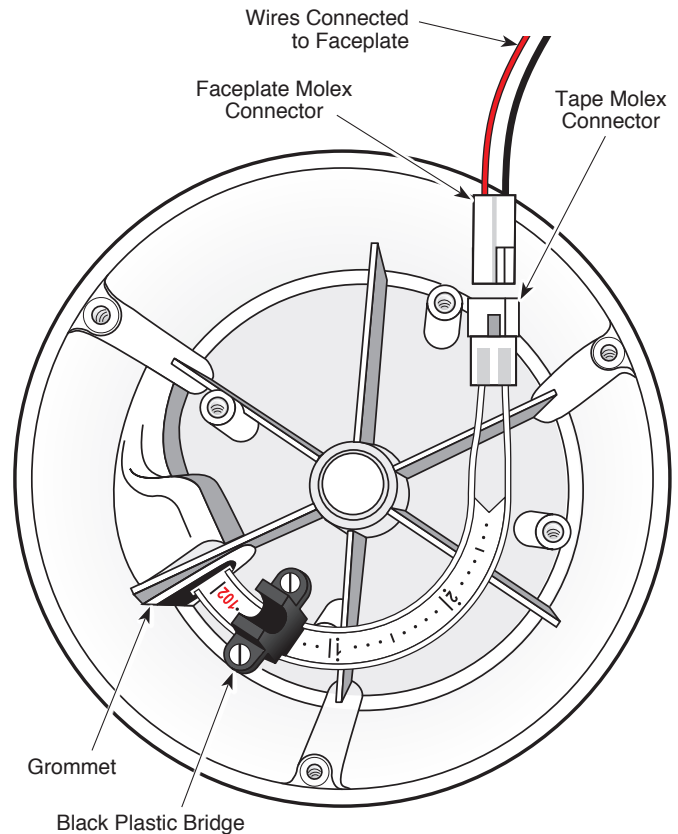

Inside View of 101 P2 Reel Hub
Showing Tape Connection Detail

8. Connect the Tape Molex Connector to the Faceplate Molex Connector.
9. With the Probe in a glass of tap water, turn the Water Level Meter to the 'ON' position. If the connections are correct, the buzzer and light on the Meter will be activated. Check connections if the buzzer does not sound.
10. Replace the Faceplate on the Reel and re-secure the three screws.
11. Slowly wind the Tape onto the Reel, holding to ensure no slack.

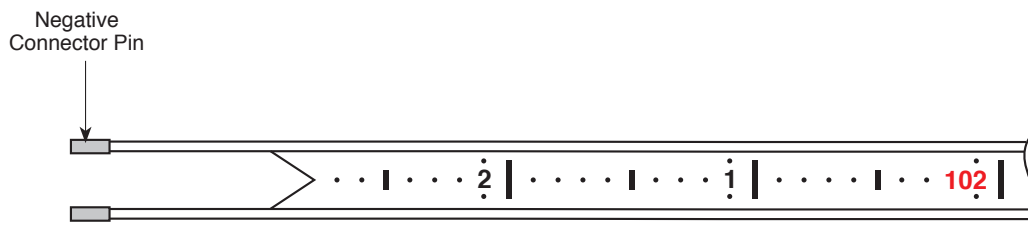

®Solinst is a Registered Trademark of Solinst Canada Ltd.

Printed in Canada
January 23, 2014
(#108708)

For further information contact: Solinst Canada Ltd.
Fax: +1 (905) 873-1992; (800) 516-9081 Tel: +1 (905) 873-2255; (800) 661-2023
35 Todd Road, Georgetown, Ontario Canada L7G 4R8
Web Site: www.solinst.com E-mail: instruments@solinst.com

Solinst®

Tools and Materials Needed

1. Tape Splice Kit - Crimp Style (#110277)
2. Scissors or Shears
3. Wire Stripper
4. Ferrule Crimp Tool (see photo)
5. Molex Crimp Tool (see photo)
6. Heat Gun
7. Soldering Iron (if using polyethylene tape)
8. Solder Wire with Acid Flux (if using polyethylene tape)
9. Acetone or Lacquer Thinner (if using polyethylene tape)



Tape Splice Kit (#110277)

Instructions

1. Cut the replacement tape and original tape at a FT or M marking. Cut each tape back by 2.5/100 ft (2.5 markings), or by 7 mm (7 markings) if using metric tape. See diagram.

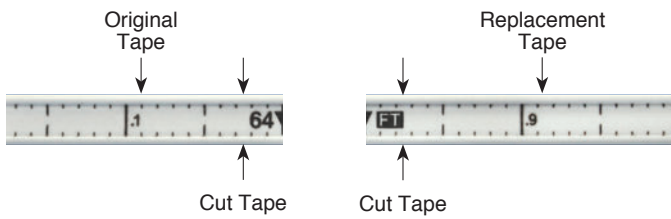

2. Cut both the replacement tape and original tape ends along the wire leads approximately 1" (25 mm), then remove the section of tape between the wire leads.
3. Strip the wire leads on both tapes 0.2" (5 mm), so the ferrules slide easily onto the lead ends.



Notes:

1. If you are splicing the laser marked tape to heat embossed polyethylene tape, you will need to pre-tin the wires of the polyethylene tape before installing the ferrules. Pre-tin the wires by applying a thin layer of acid flux and solder to the wires using tip of soldering iron. After using the flux, clean the wires with acetone or lacquer thinner.
2. Ensure each ferrule is slid onto the lead end far enough that the metal end of the ferrule is crimped onto the stripped wire.

4. You may need to twist the wires so they slide easier into the ferrules. Use a ferrule crimp tool to connect a ferrule to each stripped lead end. See photo of tool options above on right.



Ferrule Crimp Tool Options (20 AWG)

5. Slide the piece of 3" (7.6 cm) long 3/8" (9.5 mm) diameter heat shrink over one of the tapes, and push out of the way.



6. Push the ferrules on each lead wire into the butt connectors as far as possible. Use the Molex crimp tool to attach the connectors to the ferrules. Use the first (red 20-18 AWG) position on the crimp tool. See photo of tool options below.



Molex Crimp Tool Options (20-18 AWG)

Continued overleaf...

7. With the Probe in a glass of tap water, turn the Water Level Meter to the 'ON' position. If the connections are correct, the buzzer and light on the Meter will be activated. Check connections if the buzzer does not sound.
8. Use the heat gun to shrink each butt connector's insulation.
9. Push the piece of heat shrink over the connection, use the heat gun and apply heat onto the heat shrink starting in the middle and smoothing out any air pockets that form under the heat shrink. Press the heat shrink onto the connection with your fingers.



Note: Be careful not to melt the tape with the heat gun.

Step 1

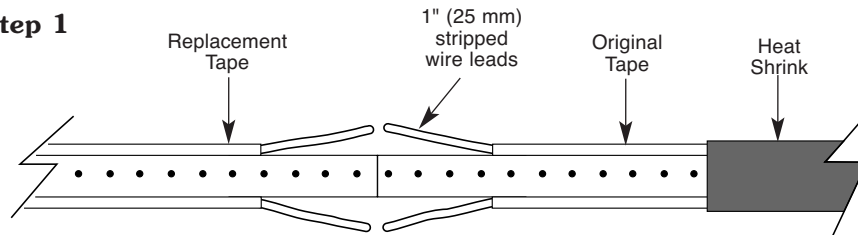

Step 2

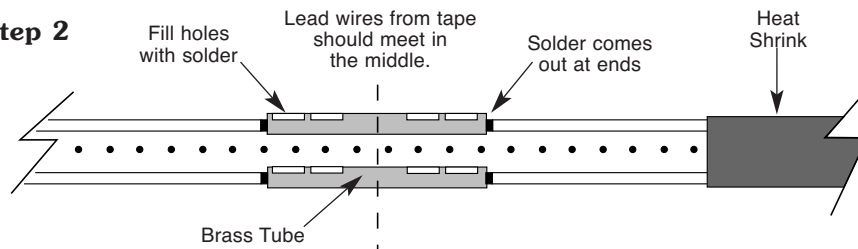

Tools and Materials Needed

1. Tape Splice Kit (#100217)
2. Tape/Probe on Tape
3. Wire Cutter
4. Wire Stripper
5. Soldering Iron
6. Solder Wire with Liquid Acid Flux
7. Acetone or Lacquer Thinner
8. Heat Gun

Instructions

1. Slip the 2 pieces of heat shrink over the tape and push out of the way. The 3.5" (90 mm) piece of heat shrink goes on first, then the 2.5" (65 mm) piece. Cut tapes along the wire leads approximately 1" (25 mm) and strip the wire leads (both ends of the tapes should be the same).
2. Pre-tin the wires by applying a thin layer of acid flux and solder to the wires using tip of soldering iron.

3. Slip the wire leads into the brass tubes. The wire leads from the tapes should meet in the middle.
4. Solder the wire leads into the brass tubes using the holes provided. Use a liquid acid flux to help wires accept solder and create a solid joint. The solder should come out of the tube ends. **After using flux, clean brass tubes with acetone or lacquer thinner.**

Note: Be careful not to melt the tape with the heat gun.

5. Push the 2.5" (65 mm) piece of heat shrink over the connection, use the heat gun and apply heat onto the heat shrink starting in the middle and smoothing out any air pockets that form under the heat shrink. Press the heat shrink onto the connection with your fingers.
6. Push the 3.5" (90 mm) piece of heat shrink over top of the connection, apply heat and seal as in step 5 above.

® Solinst is a registered trademark of Solinst Canada Ltd.

May 28, 2008

For further information contact: Solinst Canada Ltd.
Fax: +1 (905) 873-1992 Tel: +1 (905) 873-2255 or (800) 661-2023
(#107695) 35 Todd Road, Georgetown, Ontario Canada L7G 4R8
Web Site: www.solinst.com E-mail: instruments@solinst.com

Solinst®

Tools and Materials Needed

1. Handle Assembly (#103563)
2. Phillips or Robertson Screwdriver
3. Needle Nose Pliers

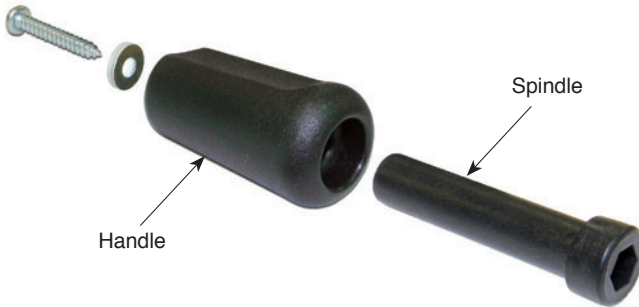

Handle Assembly (#103563)

Instructions

1. Place the reel on a flat surface, with the faceplate up. Use the Phillips or Robertson screwdriver to undo the three screws holding the faceplate to the hub.
2. Remove the faceplate and disconnect the Molex connector that attaches the faceplate electronics to the tape.
3. Use the needle nose pliers to stabilize the spindle, while using the screwdriver to remove the screw holding the handle to the faceplate. Remove the old handle assembly.
4. Take the new handle assembly, insert the spindle into the top of the handle, and center the spindle over the hole in the front of the faceplate.
5. Slide the washer over the screw and use the screw to secure the new handle from the back of the faceplate, while stabilizing the spindle with the pliers.
6. Reconnect the Molex connector and attach the faceplate.

Tools and Materials Needed

1. SC Series Replacement Hub Assembly (#103561)
 - Molded Hub (#102157)
 - Retaining Ring (#102159)
 - 2 x Stainless Steel Washers (#102560)
 - Nylon Washer (#103507)
 - Clamp (#102164)
 - 2 Robertson Screws (#103494)
 - 6 x Phillips/Robertson Screws (#103485)
 - Grommet (#102864)
 - Black Delrin Spacer (not used for SC2000 reels) (#102163)
2. Phillips Screwdriver
3. Robertson (Square head) Screwdriver
4. Retaining Ring Pliers (Solinst pt#103546 or similar)
5. Molex Pin Extraction Tool (available at most tool outlets)

Hub Side View

Hub Inside View



101/102 Replacement Hub Assembly

Removing the Old Hub

1. Unwind the tape/cable from the hub and pull it through the grommet until you come to the end.
2. Use the Phillips or Robertson screwdriver to undo the three screws holding the faceplate to the hub.
3. Remove the faceplate and disconnect the Molex connector that attaches the faceplate electronics to the tape/cable.
4. Remove the two Robertson screws holding the clamp over the tape/cable inside the hub and remove the clamp.
5. Use the Molex pin extraction tool to remove the pins from the tape/cable Molex connector, noting the polarity. The negative pin is removed from the terminal on the pointed side of the Molex connector.
6. Pull the tape/cable through the grommet and remove it from the reel.
7. Use the retaining ring pliers to remove the retaining ring holding the hub to the centre rod of the frame. Remove the three washers.

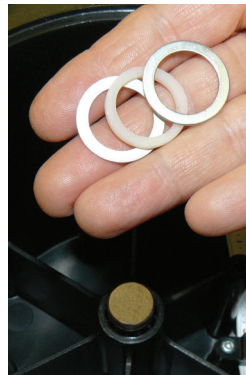
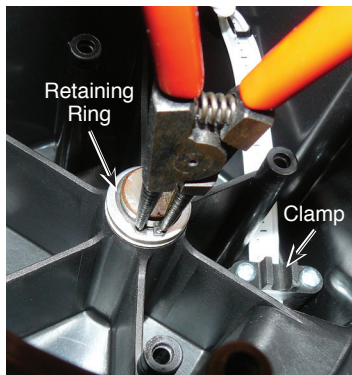

8. Pull the hub and attached backplate from the frame.
9. Remove the three screws holding the hub to the backplate.

Attaching the New Hub

10. Fasten the three screws to secure the backplate to the new hub (see photo at right).
11. Ensure the black delrin spacer is installed on the centre rod of the frame and the brake pad is flush with the back of the frame. Slide the hub and backplate back onto the frame (See photo at right).



Note: SC2000 reels do not need the spacer, as there is a shoulder on the centre rod.

12. Replace the three washers over the centre rod (nylon washer between the two stainless steel washers) and reinstall the retaining ring on the centre rod.
13. Feed the tape/cable through the grommet in the new hub (grommet may need to be installed in hub opening).
14. By hand, insert the pins back into the Molex connector. The negative pin is inserted into the terminal on the pointed side of the Molex connector, and the positive pin into the other/middle terminal.

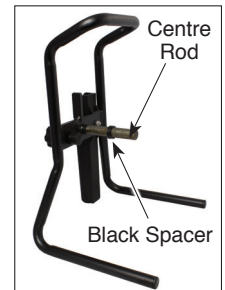

Note: Model 101: the negative pin is on the top of the tape, numbers facing up. Model 102: the negative pin is the male pin.

15. Position the tape/cable inside the hub, with the clamp over top and numbers facing up. Refasten the two screws to secure the tape/cable to the new hub.
16. Connect the Molex connector from the faceplate to the tape/cable.
17. With the Probe in a glass of tap water, turn the Water Level Meter to the 'ON' position. If the connections are correct, the buzzer and light on the Meter will be activated. Check connections if the buzzer does not sound.
18. Align the faceplate on the hub and re-secure the three screws.
19. Slowly wind the tape/cable onto the reel, holding to ensure no slack.

®Solinst is a registered trademark of Solinst Canada Ltd.